

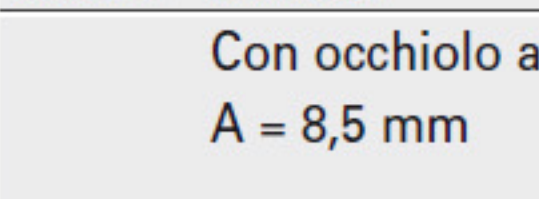

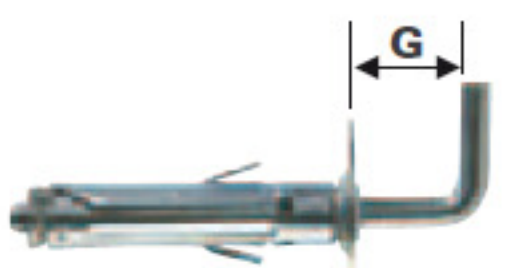

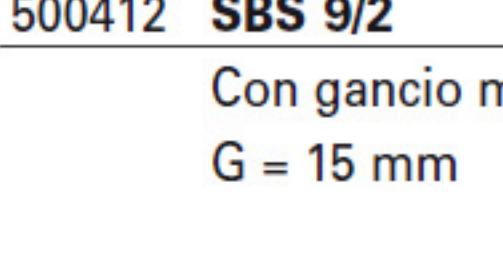

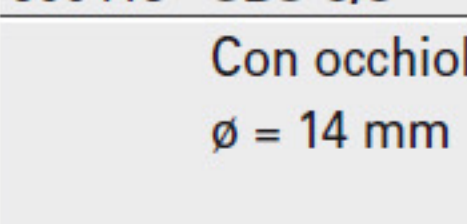

fischer SBS 8 - SBS 9

tassello in acciaio

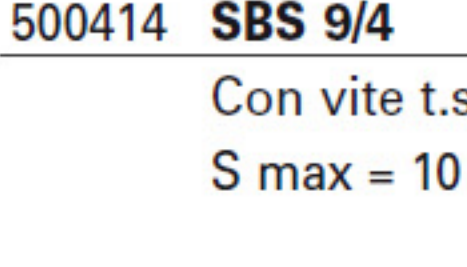
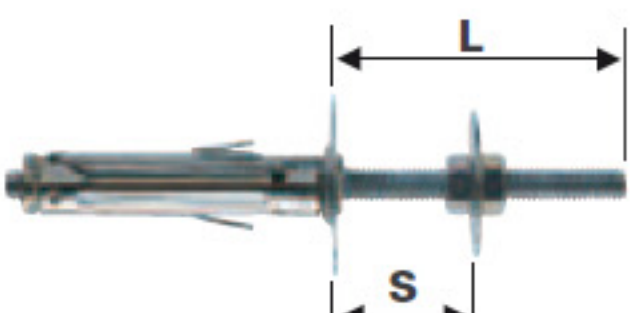
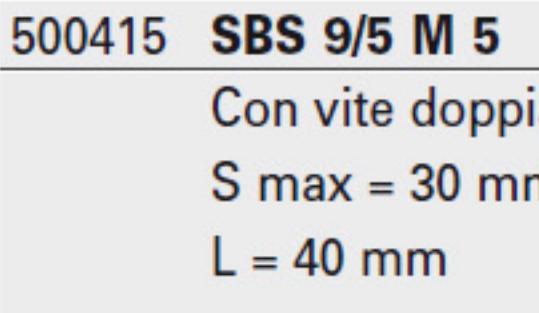
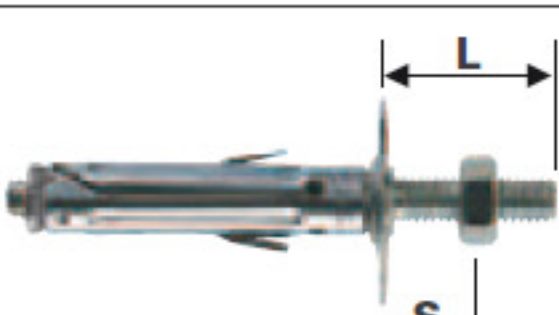
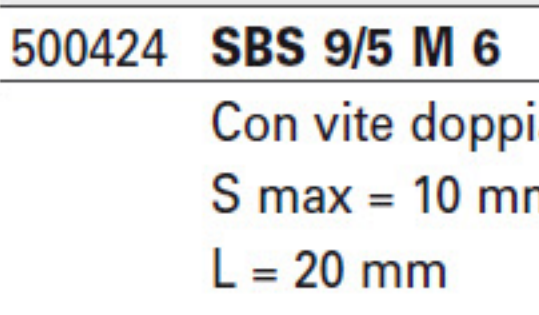
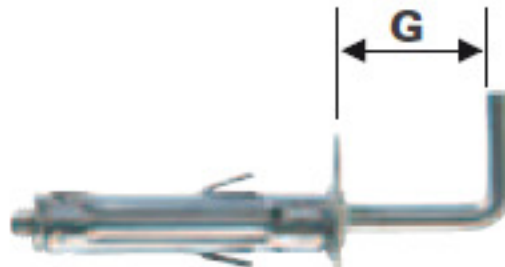
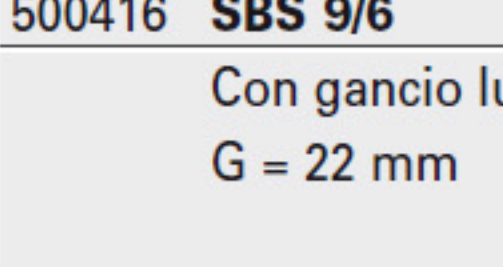
FAMIGLIA PRODOTTI

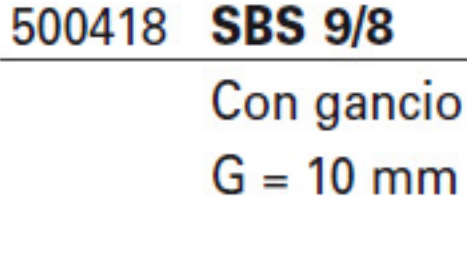
art. n.	descrizione	confezione pezzi	art. n.	descrizione	confezione pezzi
	500401 SBS 8/1 Con occhio aperto A = 8 mm	50		500411 SBS 9/1 Con occhio aperto A = 8,5 mm	50
	500402 SBS 8/2 Con gancio medio G = 12 mm	100		500412 SBS 9/2 Con gancio medio G = 15 mm	100
	500403 SBS 8/3 Con occhio chiuso $\phi = 13$ mm	50		500413 SBS 9/3 Con occhio chiuso $\phi = 14$ mm	50
	500404 SBS 8/4 Con vite t.s.c. taglio combinato S max = 10 mm	100		500414 SBS 9/4 Con vite t.s.c. taglio combinato S max = 10 mm	100
	500405 SBS 8/5 Con vite doppia M 4 S max = 25 mm L = 35 mm	50		500415 SBS 9/5 M 5 Con vite doppia M 5 S max = 30 mm L = 40 mm	50
				500424 SBS 9/5 M 6 Con vite doppia M 6 S max = 10 mm L = 20 mm	50
				500416 SBS 9/6 Con gancio lungo G = 22 mm	50
	500408 SBS 8/8 Con gancio corto G = 9 mm	100		500418 SBS 9/8 Con gancio corto G = 10 mm	100
				500420 SBS 9/10 Con gancio regolabile con vite	50

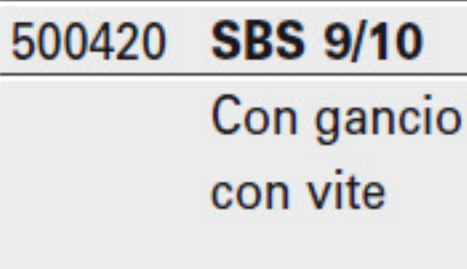
FAMIGLIA PRODOTTI

Adatto per

- calcestruzzo
- mattone pieno
- pietra e materiale compatto

Per fissare

- strutture pensili
- lampade
- pensili
- controsoffitti
- pendinature
- fili biancheria

DESCRIZIONE PRODOTTO

Generalità

- Tassello in acciaio disponibile nelle misure: 8 e 9 mm di diametro.
- Vasta gamma di accessori premontati in acciaio zincocromato.
- L'espansione si ottiene per richiamo del cono filettato avvitando l'accessorio.

Vantaggi

- Le schermature del tassello in acciaio zincocromato consentono un'efficace espansione.
- Le alette laterali impediscono al tassello di ruotare all'interno del foro.
- L'ampia gamma di accessori lo rende utilizzabile in moltissime applicazioni.

Tipo di installazione

- A filo parete.

Informazioni utili per l'installazione

- Si raccomanda di scegliere l'accessorio più idoneo e il corretto diametro del tassello in relazione al tipo di carico.



MONTAGGIO

SBS 8/4 e SBS 9/4

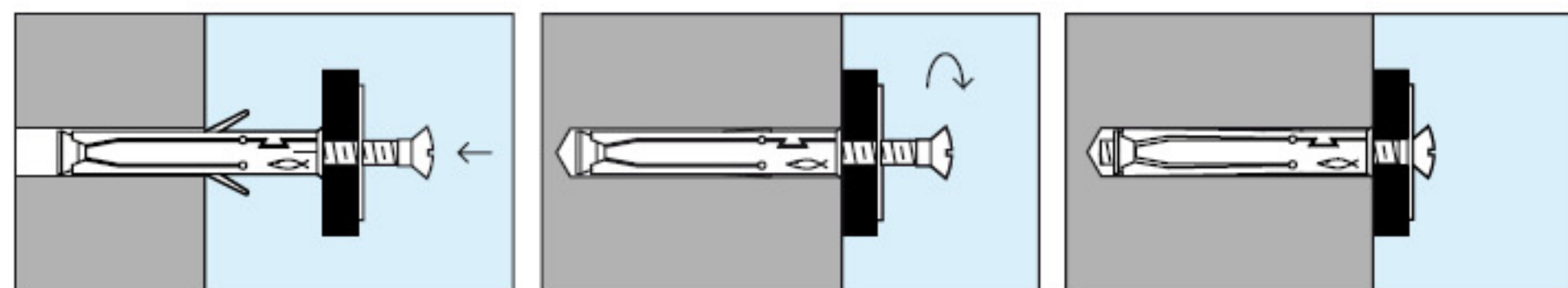

SBS 9/11 e SBS 9/12

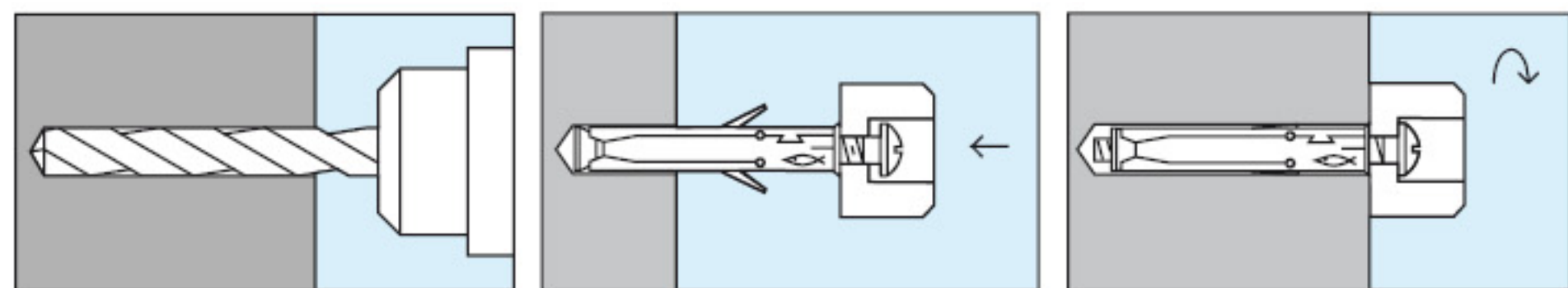

SBS 9/10

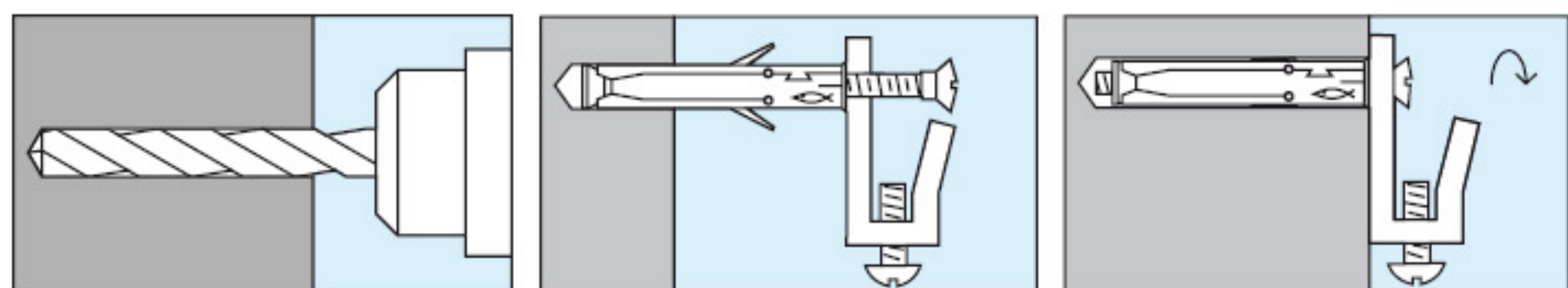

Si raccomanda un'accurata pulizia del foro prima dell'installazione.

DATI TECNICI

Tassello	Lt	ϕf	P	ϕv	ϕr
SBS 8	40	8	50	M 4	22
SBS 9	45	9	55	M 5	26

Valori di estrazione in daN

(1 daN \approx 1 kg)

Tassello	SBS 8/1*	SBS 8/2*	SBS 8/3*	SBS 8/4	SBS 8/5	SBS 8/8*
Calcestruzzo R 250(1)	40*	40*	40*	230	230	80*

* Piegamento accessorio

(1) 250 kg/cm²

Tassello	SBS 9/1*	SBS 9/2*	SBS 9/3*	SBS 9/4	SBS 9/5	SBS 9/6*	SBS 9/8*
Calcestruzzo R 250(1)	60*	80*	60*	300	300	50*	160*

* Piegamento accessorio

(1) 250 kg/cm²

Si consiglia l'adozione di un adeguato coefficiente di sicurezza secondo i casi (vedi "Guida tecnica").

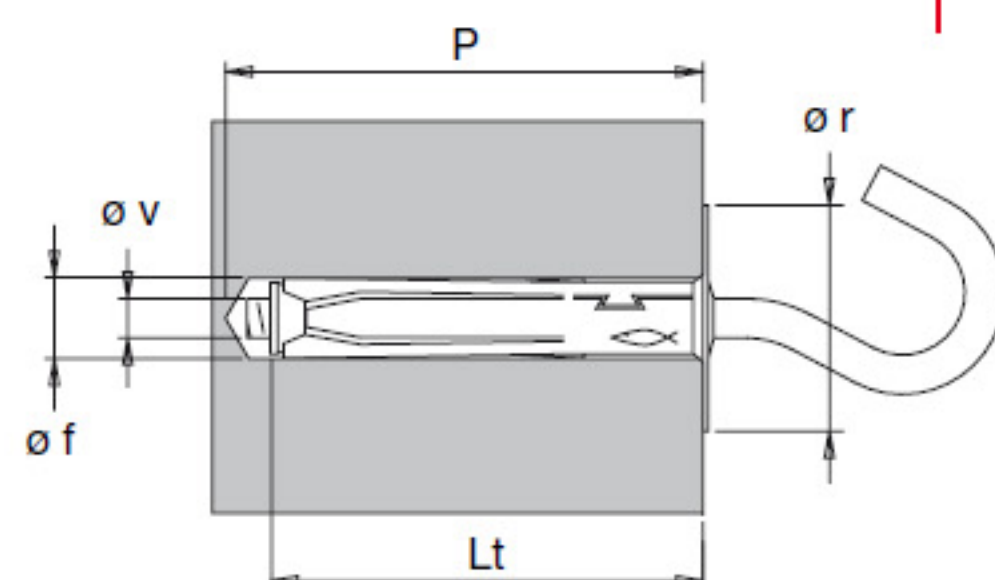

Lt = lunghezza tassello mm
 ϕf = diametro punta mm
 P = profondità minima foro mm
 ϕv = diametro vite mm
 ϕr = diametro rosetta mm