











# fischer SBS 8 - SBS 9

tassello in acciaio

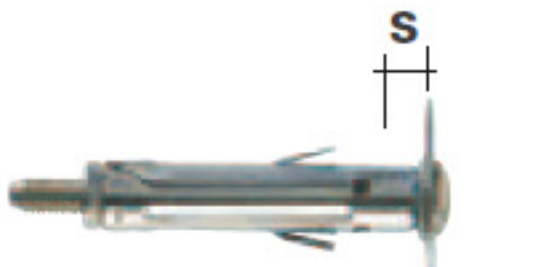
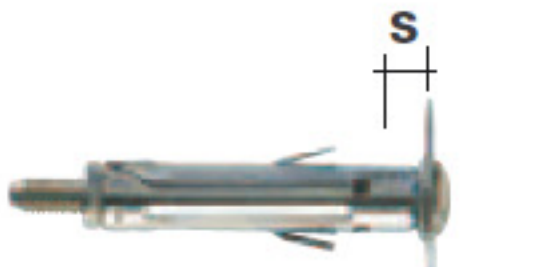
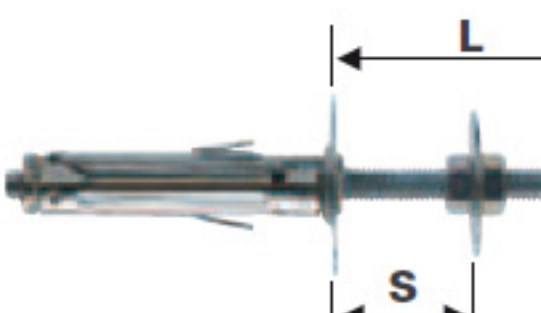
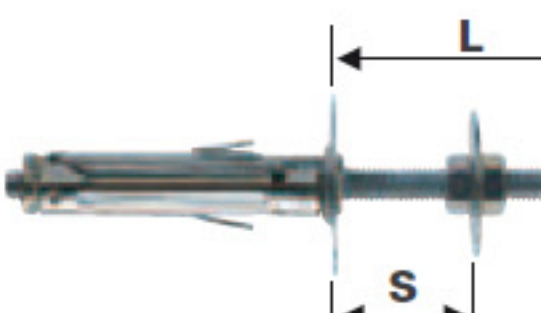
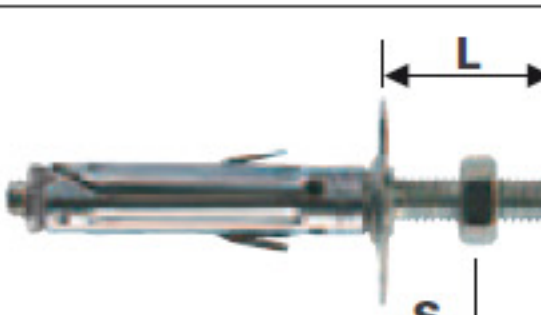
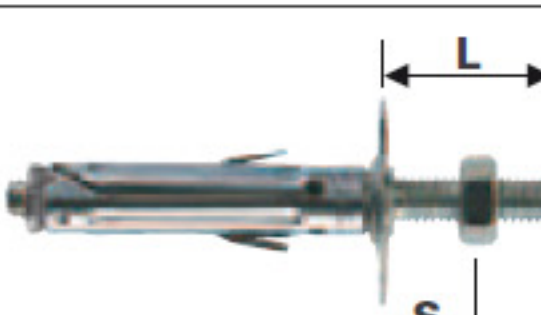
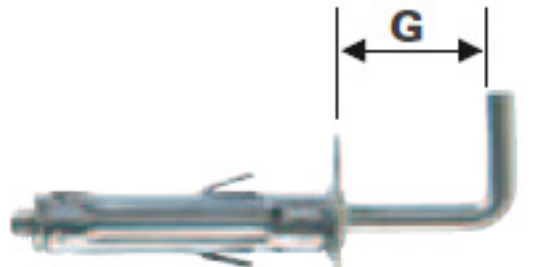
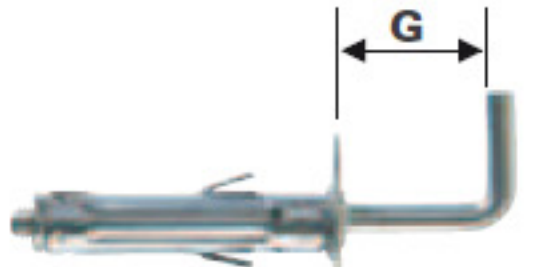
## FAMIGLIA PRODOTTI

art. n.	descrizione	confezione pezzi	art. n.	descrizione	confezione pezzi
	<b>500401 SBS 8/1</b> Con occhiolo aperto A = 8 mm	50		<b>500411 SBS 9/1</b> Con occhiolo aperto A = 8,5 mm	50
	<b>500402 SBS 8/2</b> Con gancio medio G = 12 mm	100		<b>500412 SBS 9/2</b> Con gancio medio G = 15 mm	100
	<b>500403 SBS 8/3</b> Con occhiolo chiuso ø = 13 mm	50		<b>500413 SBS 9/3</b> Con occhiolo chiuso ø = 14 mm	50
	<b>500404 SBS 8/4</b> Con vite t.s.c. taglio combinato S max = 10 mm	100		<b>500414 SBS 9/4</b> Con vite t.s.c. taglio combinato S max = 10 mm	100
	<b>500405 SBS 8/5</b> Con vite doppia M 4 S max = 25 mm L = 35 mm	50		<b>500415 SBS 9/5 M 5</b> Con vite doppia M 5 S max = 30 mm L = 40 mm	50
				<b>500424 SBS 9/5 M 6</b> Con vite doppia M 6 S max = 10 mm L = 20 mm	50
				<b>500416 SBS 9/6</b> Con gancio lungo G = 22 mm	50
	<b>500408 SBS 8/8</b> Con gancio corto G = 9 mm	100		<b>500418 SBS 9/8</b> Con gancio corto G = 10 mm	100
				<b>500420 SBS 9/10</b> Con gancio regolabile con vite	50

## FAMIGLIA PRODOTTI

### Adatto per

- calcestruzzo
- mattone pieno
- pietra e materiale compatto

### Per fissare

- strutture pensili
- lampade
- pensili
- controsoffitti
- pendinature
- fili biancheria

## DESCRIZIONE PRODOTTO

### Generalità

- Tassello in acciaio disponibile nelle misure: 8 e 9 mm di diametro.
- Vasta gamma di accessori premontati in acciaio zincocromato.
- L'espansione si ottiene per richiamo del cono filettato avvitando l'accessorio.

### Vantaggi

- Le schermature del tassello in acciaio zincocromato consentono un'efficace espansione.
- Le alette laterali impediscono al tassello di ruotare all'interno del foro.
- L'ampia gamma di accessori lo rende utilizzabile in moltissime applicazioni.

### Tipo di installazione

- A filo parete.

### Informazioni utili per l'installazione

- Si raccomanda di scegliere l'accessorio più idoneo e il corretto diametro del tassello in relazione al tipo di carico.



## MONTAGGIO

SBS 8/4 e SBS 9/4

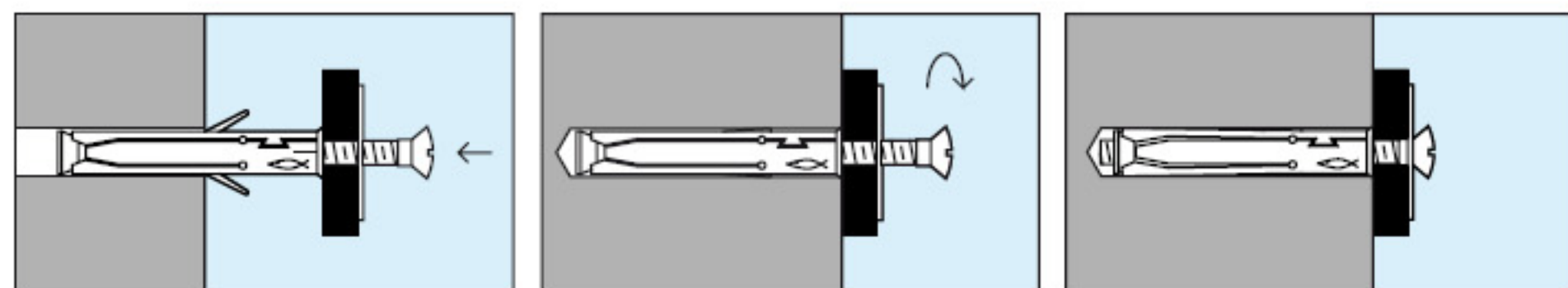

SBS 9/11 e SBS 9/12

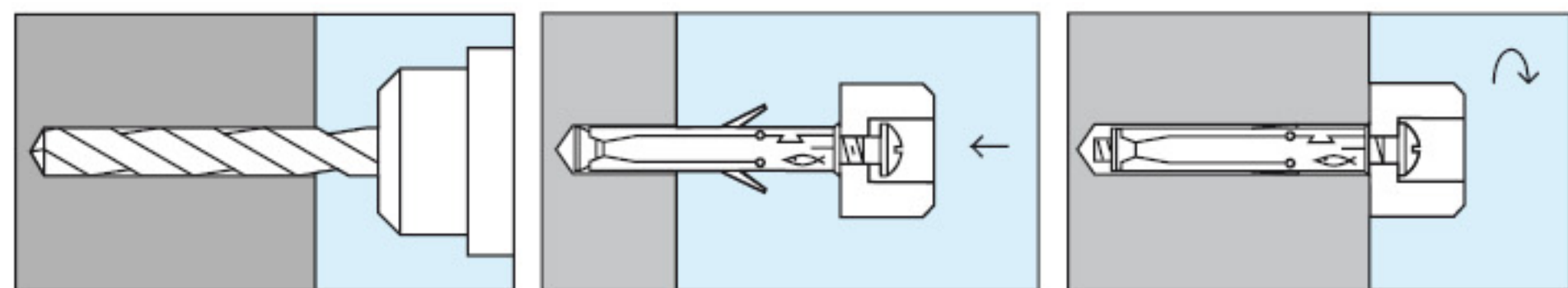

SBS 9/10

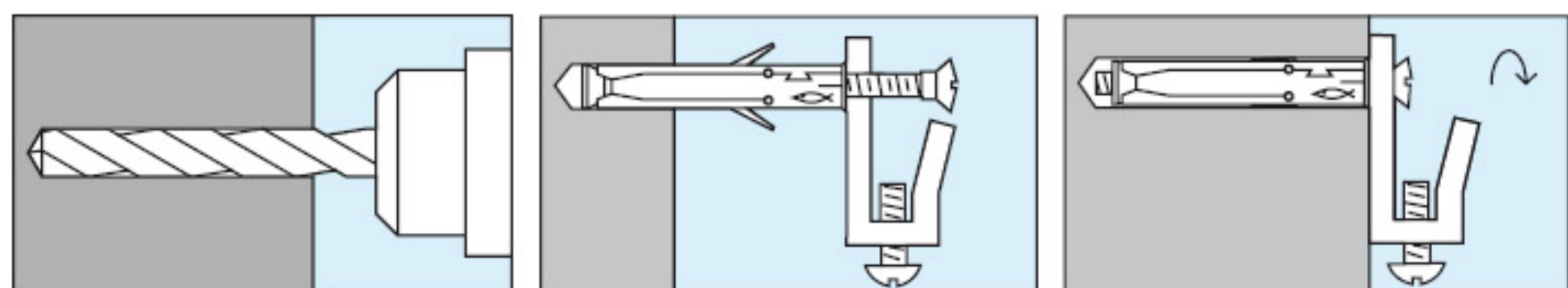

Si raccomanda un'accurata pulizia del foro prima dell'installazione.

## DATI TECNICI

Tassello	Lt	øf	P	øv	ør
<b>SBS 8</b>	40	8	50	M 4	22
<b>SBS 9</b>	45	9	55	M 5	26

Valori di estrazione in daN

(1 daN ≈ 1 kg)

Tassello	SBS 8/1*	SBS 8/2*	SBS 8/3*	SBS 8/4	SBS 8/5	SBS 8/8*
Calcestruzzo R 250(1)	40*	40*	40*	230	230	80*

\* Piegamento accessorio

(1) 250 kg/cm<sup>2</sup>

Tassello	SBS 9/1*	SBS 9/2*	SBS 9/3*	SBS 9/4	SBS 9/5	SBS 9/6*	SBS 9/8*
Calcestruzzo R 250(1)	60*	80*	60*	300	300	50*	160*

\* Piegamento accessorio

(1) 250 kg/cm<sup>2</sup>

Si consiglia l'adozione di un adeguato coefficiente di sicurezza secondo i casi (vedi "Guida tecnica").

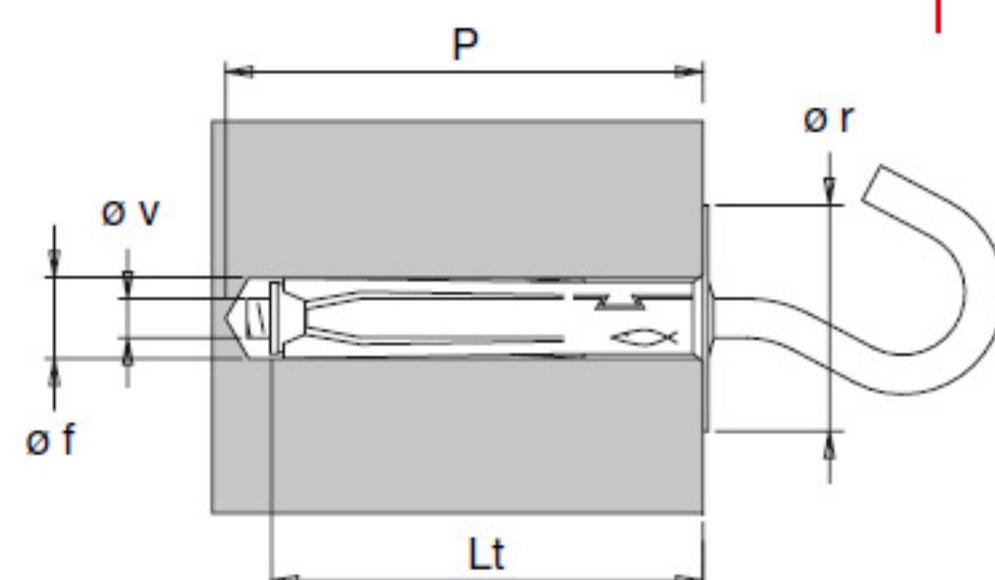

Lt = lunghezza tassello mm  
 øf = diametro punta mm  
 P = profondità minima foro mm  
 øv = diametro vite mm  
 ør = diametro rosetta mm